

**Advanced Training
for the Weapons Designer**

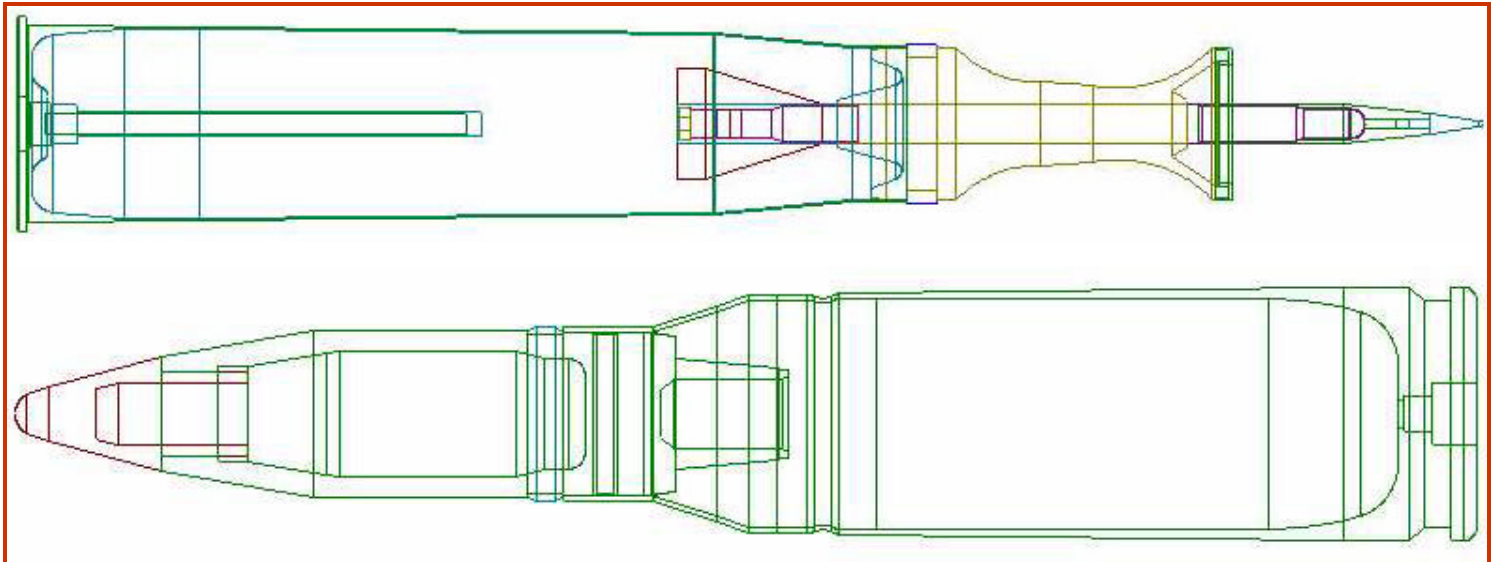

➤ ARROW TECH ➤

“If You Can’t Get a Bigger Target”

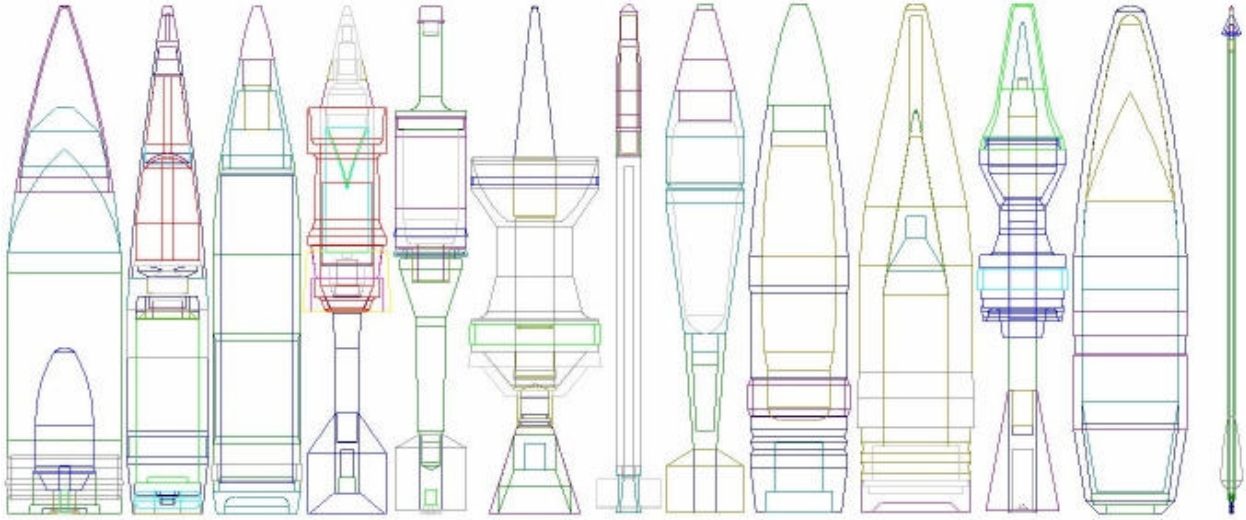

COURSE	PAGE	DURATION (DAYS)
Basic PRODAS	3	3
Basic PRODAS (Extended)	5	5
Advanced User PRODAS	7	3
BALANS (Projectile Balloting Analysis)	8	3
CASAS (Case/Chamber Interaction)	10	3
SDK (Software Development Kit)	11	3
Guidance Navigation and Control Prototype Tool	12	3
RADAR Data Reduction: Basic User Course	13	3
Spark Range Data Reduction: Basic User Course	14	3

BASIC PRODAS

Using PRODAS to SOLVE Problems

With PRODAS you can create a projectile model, calculate mass properties, estimate a full set of aerodynamic coefficients, Fly 4DOF, 6DOF and body fixed trajectories, and calculate penetration of KE projectiles and shaped charge warheads

Course Duration: 3 Days

Class Size: 5 Students (Maximum of 10)

Required Materials: Computer access for each student

Purpose:

The course is designed to help the new user learn how to use PRODAS for projectile modeling and analysis. It shows the student how to execute the basic PRODAS modules as well as the basic theory behind them.

- * Modeling
- * Mass Properties
- * Aerodynamic Theory and Coefficient Prediction
- * Aerodynamic Stability Theory and Prediction
- * Interior Ballistics
- * Trajectories
- * Ballistic and Firing Tables
- * 3D Visualizer / animation
- * Basic Terminal Effects
- * Dispersion assessment
- * PRODAS reference books

Syllabus

Day 1:

- Introductions
- Expectations for Seminar
- PRODAS V3 Capabilities
 - * Extensible Database
 - * Customized Analysis Code
 - * Visualization
 - * Reference Books
- Model Editor Module
 - * Creating PRODAS Models
 - * Assigning Physical Function
 - * Assigning Aerodynamic Function
 - * Calculating Mass Properties
 - * In Class Lab
- Aerodynamic Coefficient Definitions
 - * Projectile Axis
 - * Force and Moments Definitions
 - * Aerodynamic Predictor Module
 - * In Class Lab





PRODAS Syllabus (continued)

Day 2:

- Stability Evaluation
 - * Static and Gyroscopic Stability
 - * Linear Theory
 - * Dynamic Stability
 - * Aerodynamic Jump
 - * Aero Stability Module
 - * In Class Lab
- Stability Evaluation (Continued)
 - * In Class Lab
- Dispersion
 - * Definitions and Conversion Methods
 - * Statistical Analysis
 - * Lot Acceptance Testing Simulation
- Trajectory
 - * 4 Degree of Freedom definitions
 - * 6 Degree of Freedom definitions
 - * In Class Lab (Visualization of Possible Flight Instabilities)
- Firing Tables
 - * Definitions (Artillery, Direct Fire, Mortar, Line of Sight, Ballistic Tables)

Day 3:

- Terminal Ballistics
 - * Kinetic Energy Penetration through Monolithic Armor
 - * In Class Lab
- Interior Ballistics
 - * Theory and Definitions
 - * Empirical
 - * Baer Frankle Model
 - * In Class Lab
- Controlled Trajectory Simulation
 - * Definition
 - * Deploying Control Surfaces
 - * Canards
 - * Explosive Strips
 - * Force Injection
 - * Assessing Control Authority
 - * In Class Lab
- Extracting Real Aeros
 - * Wind Tunnel
 - * Radar Data
 - * Yaw Card
 - * Yaw Sonde
 - * Spark Range
- Special Topics – Class Discussion – Seminar Summary and Wrap Up

BASIC PRODAS—Extended

This an extended version of the PRODAS 3 day course and includes a discussion on System Effectiveness. The extra two days allows for more in depth discussion where students have the time to work on specific projects related to their work.

The 5 day course is often beneficial to our foreign customers where the language barrier may slow down the pace of the course.

Course Duration: 5 Days

Class Size: 5 Students (Maximum of 10)

Required Materials: Computer access for each student

Purpose:

This is a longer version of the basic PRODAS course that allows more in depth discussion of topics as well as discussions of advanced optional modules.

The same topics are taught as in the basic course along with the addition of the following modules;

- * Controlled Trajectory Simulation
- * Test Aerodynamics Extracted from Test Data
- * System Effectiveness



Syllabus

Day 1:

- Introductions
- Expectations for Seminar
- PRODAS V3 Capabilities
 - * Extensible Database
 - * Customized Analysis Code
 - * Visualization
 - * Reference Books
- Model Editor Module
 - * Creating PRODAS Models
 - * Assigning Physical Function
 - * Assigning Aerodynamic Function
 - * Calculating Mass Properties
 - * In Class Lab

Day 2:

- Aerodynamic Coefficient Definitions
 - * Projectile Axis
 - * Force and Moments Definitions
 - * Aerodynamic Predictor Module
 - * In Class Lab
- Stability Evaluation
 - * Static and Gyroscopic Stability
 - * Linear Theory
 - * Dynamic Stability
 - * Aerodynamic Jump
 - * Aero Stability Module
 - * In Class Lab
- Stability Evaluation (Continued)
 - * In Class Lab
- Dispersion
 - * Definitions and Conversion Methods
 - * Statistical Analysis
 - * Lot Acceptance Testing Simulation



Day 3:

- Trajectory
 - * 4 Degree of Freedom definitions
 - * 6 Degree of Freedom definitions
 - * In Class Lab (Visualization of Possible Flight Instabilities)
- Firing Tables
 - * Definitions (Artillery, Direct Fire, Mortar, Line of Sight, Ballistic Tables)
- Terminal Ballistics
 - * Kinetic Energy Penetration through Monolithic Armor
 - * In Class Lab

Day 4:

- Interior Ballistics
 - * Theory and Definitions
 - * Empirical
 - * Baer Frankle Model
 - * In Class Lab
- Controlled Trajectory Simulation
 - * Definition
 - * Deploying Control Surfaces
 - * Canards
 - * Explosive Strips
 - * Force Injection
 - * Assessing Control Authority
 - * In Class Lab
- Extracting Real Aeros
 - * Wind Tunnel
 - * Radar Data
 - * Yaw Card
 - * Yaw Sonde
 - * Spark Range

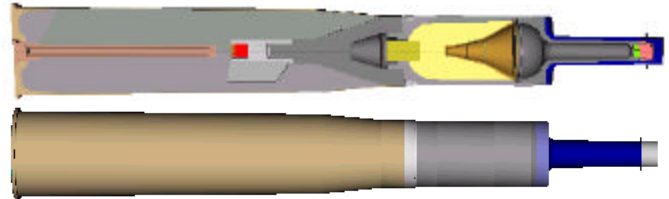

Day 5

- System Effectiveness
- Canned Simulation vs. Macro
- P_h , P_k and $P_{k/h}$, plus other parameters
- Target Modelling
- Special Topics, Class Discussion, Seminar Summary and Wrap Up

Advanced User PRODAS

Course Duration: 3 Days

Class Size: 5 Students (Maximum of 10)

Required Materials: Computer access for each student

Purpose:

The course is designed to help the experienced PRODAS user learn how to use the advanced features of PRODAS for projectile modeling and analysis. Through demonstration and hands on work the student will become familiar with the advanced PRODAS modules:

- * Projectile Tracing Tool
- * Analysis BOT (repetitive analysis tool)
- * Multiple Aero Prediction Capability
- * Controlled Trajectory
- * Guidance and Control Overview
- * Shaped Charge Penetration
- * System Effectiveness Analysis with Macros



Syllabus

Day 1:

- Projectile Modeling
 - * Projectile Tracing Tool
 - * In Class Lab
- Multiple Aero Prediction Capability
 - * Spinner/Finner
 - * Missile DATCOM
 - * MISL3
 - * Aeromanager
 - * In Class Lab

Day 2:

- Scripting and automated analysis control
 - * Analysis BOT Module
 - * Scripting examples
 - * In Class Lab
- Controlled Trajectory
 - * Combining CONTRAJ and Scripting to produce a static controlled trajectory footprint
- Guidance and Control Prototyper Overview
 - * Example of inputting guidance and control algorithm
- System Effectiveness Overview
 - * Current PRODAS Capability Overview
 - * Initial Conditions Generator Module
 - * In Class Lab

Day 3:

- Guidance and Control System Effectiveness
 - * Calculating System Accuracy with the Guidance and Control Prototyper
 - * In Class Lab



Balans Projectile balloting Analysis

BALANS analyzes the dynamic response and interaction of a statistically representative, flexible projectile and a flexible gun tube during in-bore travel using a time step iterative solution. BALANS assumes the projectile is initially misaligned in the gun tube due to manufacturing tolerances. During firing, this misalignment produces secondary forces causing transverse displacement and yawing motion of the projectile as it travels from breech to muzzle.

Course Duration: 3 Days

Standard Class Size: 3 Students

Required Materials: Computer access for each student

Purpose:

This course provides an introduction to projectile balloting. It further instructs the user in the science of sabot profiling to achieve optimal mass sabot petals.

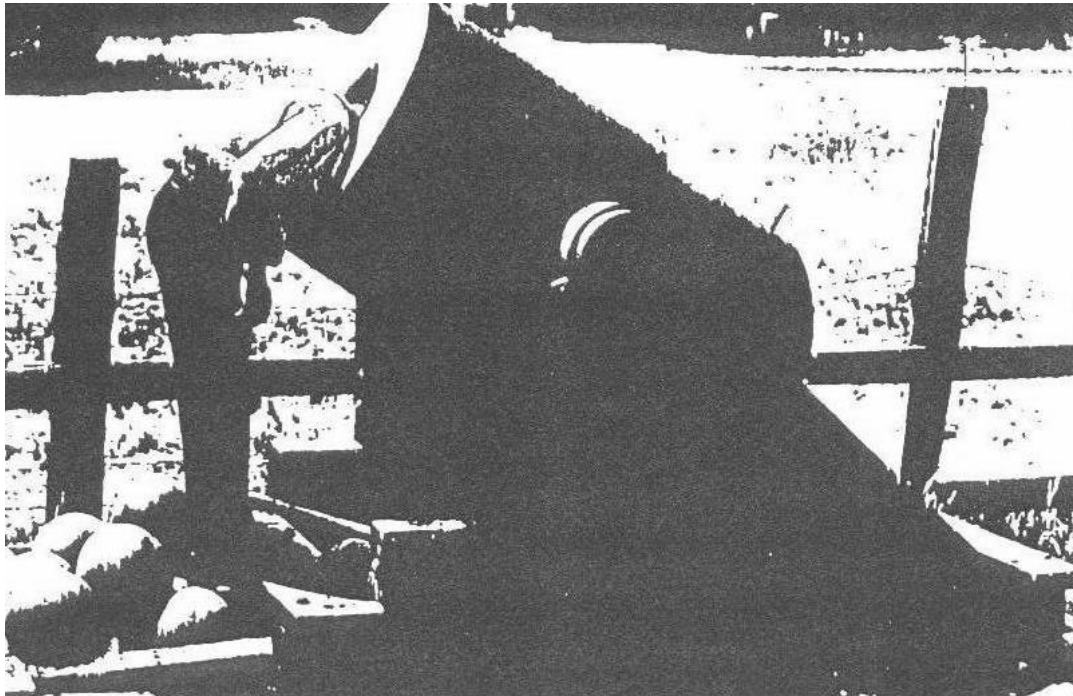



Balans Syllabus

Day 1:

- BALANS Introduction and Overview
 - * Definition
 - * History
 - * Applications at Arrow Tech
- BALANS Modeling
 - * Projectile Lumped Parameter Model
 - * Tube Model
 - * Applications at Arrow Tech
- BALANS Mathematical Model

Day 2:

- Single/Statistical Choice
- Single Analysis
 - * Problems
 - * Output Options

Day 3:

- BALANS Statistical Analysis
 - * Inputs
 - * Aerodynamic Dispersion Sensitivities
 - * Output Options
- Advanced Options

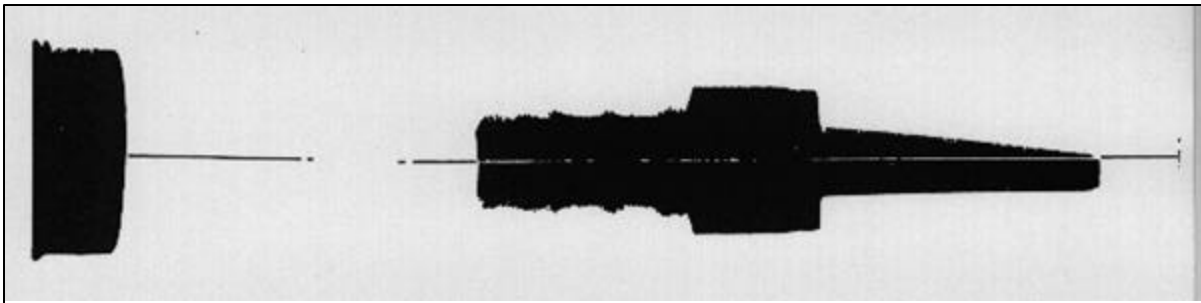

casas

Chase/chamber interaction analysis

To improve computational and parametric design efficiency, Arrow Tech has developed an analytical tool specifically to analyze cartridge cases, called CASAS (CASE Analysis System).

CASAS is a primary analytical tool to perform the elastic-plastic, dynamic analysis (including transient heat effects) required for cartridge case design.

Course Duration: 3 Days

Standard Class Size: 5 Students

Required Materials: Computer access for each student

Purpose:

This course provides an introduction to Cartridge Case-Chamber Analysis module (CASAS). It introduces students to the complexities and considerations of cartridge case design.



Syllabus

Day 1:

- CASAS Introduction and Overview
 - * Statement of analysis objectives
 - * Explanation of problem complexity
 - ◇ Initial Conditions
 - ◇ Propellant Ignition
 - ◇ Pressure Load Increase
 - ◇ Elastic Recovery
 - ◇ Residual Clearance/Interference
 - ◇ Case Extraction
- Case Modeling Basics
- Data Requirements for Analysis
- Interior Ballistics Introduction
 - * Explanation of how to develop CASAS inputs

Day 2:

- Modeling
 - * Theory and Approach
 - * Modeling Example
 - * Default Model
 - * Model Refinement
 - * Boundary Conditions
 - * Material Properties
- Analysis
 - * Additional Inputs
 - * Formatted Results
 - * Tabular and Plotted Results
 - * Case Studies/Program Uses



Day 3:

- User Example Problem
- BOT and/or CASAS Trade Study Template



SDK

Software Development kit

The Software Development Kit (SDK) will allow you to build and integrate your own analysis programs within PRODAS. Your analysis will draw from the PRODAS data and appear on the menu like any other module.

Course Duration: 3 Days

Standard Class Size: 5 Students

Required Materials: Computer access for each student

Purpose:

This course provides an introduction to the Software Development Kit and examines every aspect of a simple analysis which has been integrated into PRODAS. The intent is to enable the student to integrate his/her own analysis module into the PRODAS structure.



Syllabus

Day 1:

- SDK Introduction and Overview
 - * Arrow Tech / PRODAS Overview
 - * Software Development Toolkit (SDK) Overview
- SDK Data Manager
 - * Overview/Basics
 - * Units Processing
 - * Creating/Modifying/deleting Data Types
 - * Example(s)/Lab(s)

Day 2:

- SDK Analysis Manager
 - * Overview/Basics
 - * Creating/Modifying an Analysis Module
 - * FORTRAN Source Code Generator
 - * Example(s)/Lab(s)
- SDK Forms Manager
 - * Overview/Basics
 - * Creating/Modifying a Form and its Interface Entities
 - * Example(s)/Lab(s)

Day 3:

- Putting it all together
 - * Running FORTRAN Program
 - * Making Changes
 - * Example(s)/Lab(s)
- Advanced Topics
 - * Reference Book Editor
 - * Customizing the User Interface
 - * SDK Questions/Answers



GNC

Guidance Navigation and Control Prototype tool

This unique module combines a guidance and control simulation with a body fixed 6DOF trajectory simulation. A drag and drop editor is provided to quickly build a flight control system from common control system elements. Also provided is an “oscilloscope” feature to help design and troubleshoot the control system.

Course Duration: 3 Days

Standard Class Size: 5 Students

Required Materials: Computer access for each student

Purpose:

This course provides an introduction to the GNC Module and takes you through several tasks which provide an overview of how to use the PRODAS and Guidance Navigation and Control environment to its fullest.

Note: Teaching basic control theory is not the intent of this course.



Syllabus

Day 1:

- GN&C Prototype Tool
 - * Guided Flight in PRODAS
 - * GN&C Prototype Tool-When to use it
 - * Software Preview
 - * Building a Flight Control System (FCS)
 - * Hands-on Lab

Day 2:

- Control Element Details
 - * General Purpose Elements
 - * Control Force Elements
 - * Sensor Elements
 - * High Level Control Elements
 - * Hands on Lab

Day 3:

- Advanced Session
 - * FCS Advanced Editor Topics
 - * Experimental Control Mechanisms
 - * Guided System Simulations
 - * User Defined Control Elements
 - * Hands on Lab

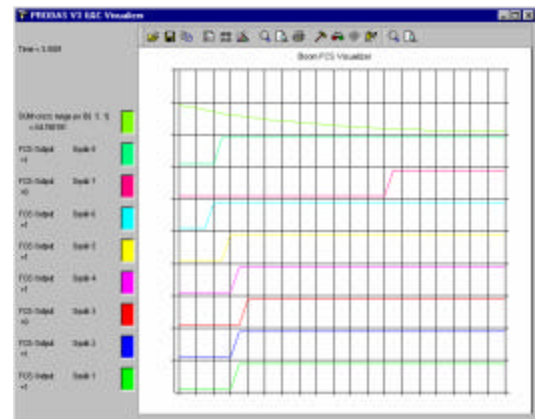
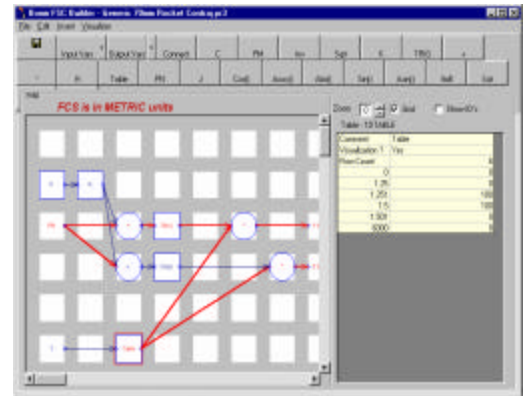

Radar Basic User Course

RADAR 2000 uses the equations of motion along with non-linear drag versus Mach Number for the most accurate computation of drag coefficients possible. A powerful differential correction technique is used to rapidly converge on a combination of selected coefficients which most accurately matches the experimental radar data.

Course Duration: 3 Days

Standard Class Size: 5 Students

Required Materials: Computer access for each student

Purpose:

This course provides the user with the basic understanding of the methodology and practice of reducing data acquired from Radar observations of free and/or guided flight to aerodynamic coefficients.

Specifically you will use RADAR.....

- To use RADAR 2000 to produce the following data from test radar data:
 - * CX vs Mach Number
 - * Roll Moment (Cld) and Roll Damping Coefficients (Clp) vs Mach
- To identify
 - * Tracer Burnout
 - * Rocket Motor Burnout
 - * Trajectory Anomalies
- To predict projectile impact



Syllabus

Day 1:

- Aerodynamic Theory
- Data Reduction Methodology
- RADAR 2000 Overview
 - * Individual Shot Analysis
 - * Shot Group Analysis

Day 2:

- RADAR 2000 Inputs
- RADAR 2000 Outputs
- RADAR 2000 Exercise #1—Basic Individual Shot
- RADAR 2000 Exercise #2—Basic Shot Group
-

Day 3:

- Advanced Event Identification
- RADAR 2000 Exercise #3—Rocket Motor
- RADAR 2000 Exercise #4—Trajectory Anomalies
- Conclusion and Discussion

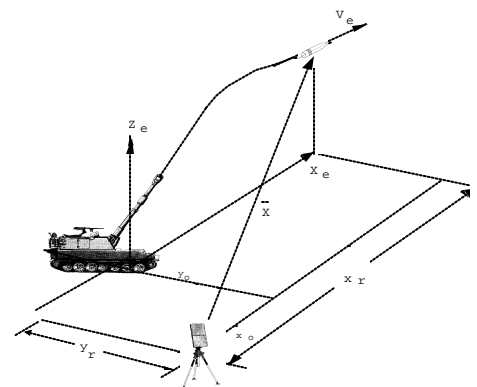

Spark Range Data Reduction Basic User Course

The Spark range is used to obtain aeroballistic coefficients to predict projectile flight. Orthogonal photographs of the model's shadow are then used to determine the spatial position and angular orientation of the test model at various instrumented sites. A chronograph system provides the times for the projectile at each station. These times together with the spatial position and orientation obtained from the orthogonal photographs provide the basic trajectory data from which the aerodynamic coefficients are extracted. These discrete times, positions, and orientations are then used by the data reduction program to determine the aerodynamic forces and moments acting on the model during the observed flight.

Course Duration: 3 Days

Standard Class Size: 5 Students

Required Materials: Computer access for each student

Purpose:

This course is designed to provide the user with a firm background in aerodynamic theory and data reduction methodology.

Topics Included in the Course are:

- Aerodynamic Theory
- Spark Range operation and instrumentation pitfalls
- How to reduce spark range data to aerodynamic coefficients
- How to use spark range derived coefficients properly to predict projectile flight.



Syllabus

Day 1:

- Introduction and Overview
- Linear Theory
 - * Numerical Integration of Time vs. Distance and Roll Motion
 - * Linear Theory Analysis of yaw and Swerve Motion
- Stability
- Flight Characteristics
- Exercise #1—Preliminary

Day 2:

- 6DOF
 - * Numerical Integration of 6DOF Equations of Motion
 - * Spin and Fin Stabilized Projectiles
- Exercise #2—Basis Data Reduction

Day 3:

- Single or Multiple Shot Analysis
 - * Presentation of Results
- Dynamic Calibration
- Exercise #2—Complex Data Reduction

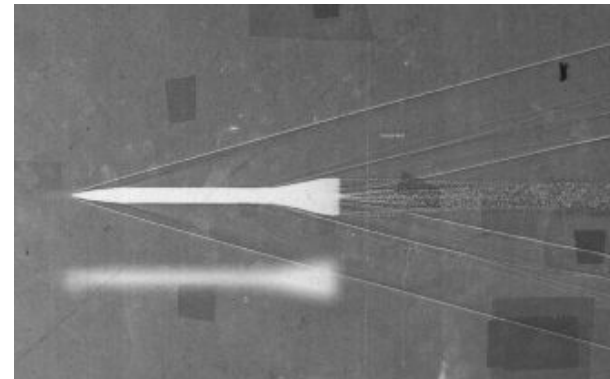

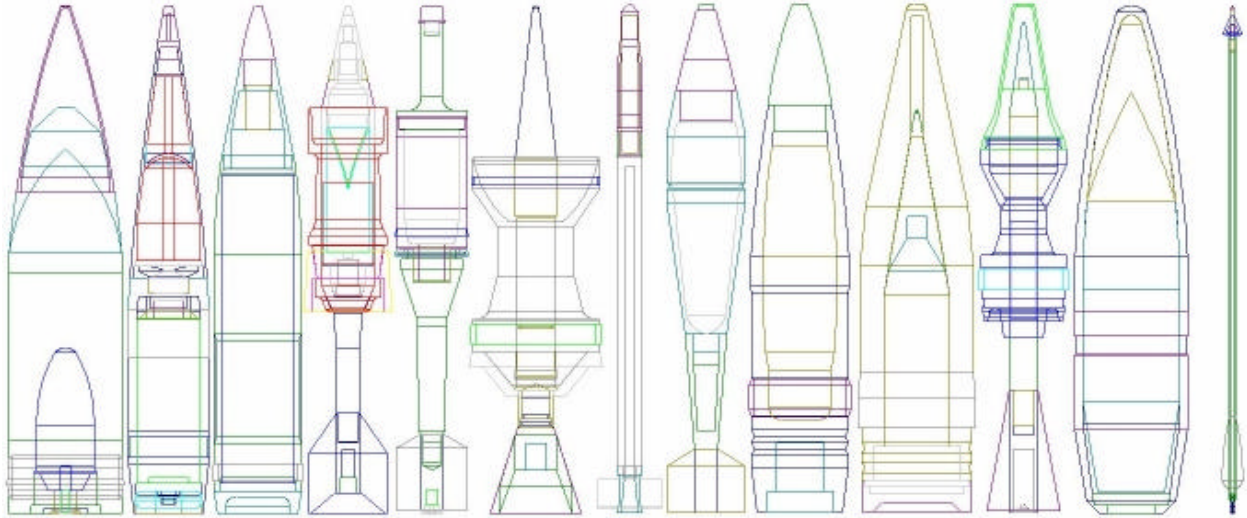

- All Arrow Tech Courses are taught by experienced aeroballistic and structural engineers currently on staff at Arrow Tech.
- Courses can be taught at Arrow Tech or at your facility.
- Contact Arrow Tech to discuss your specific needs and to schedule a course.

**Arrow tech associates, inc.
1233 Shelburne Road; d8
South Burlington, Vermont 05403**

802-865-3460 Phone

802-865-3470 Fax

info@prodas.com

www.prodass.com

ARROW TECH

“If You Can’t Get a Bigger Target”